

OUTLINE DIMENSIONAL DRAWING

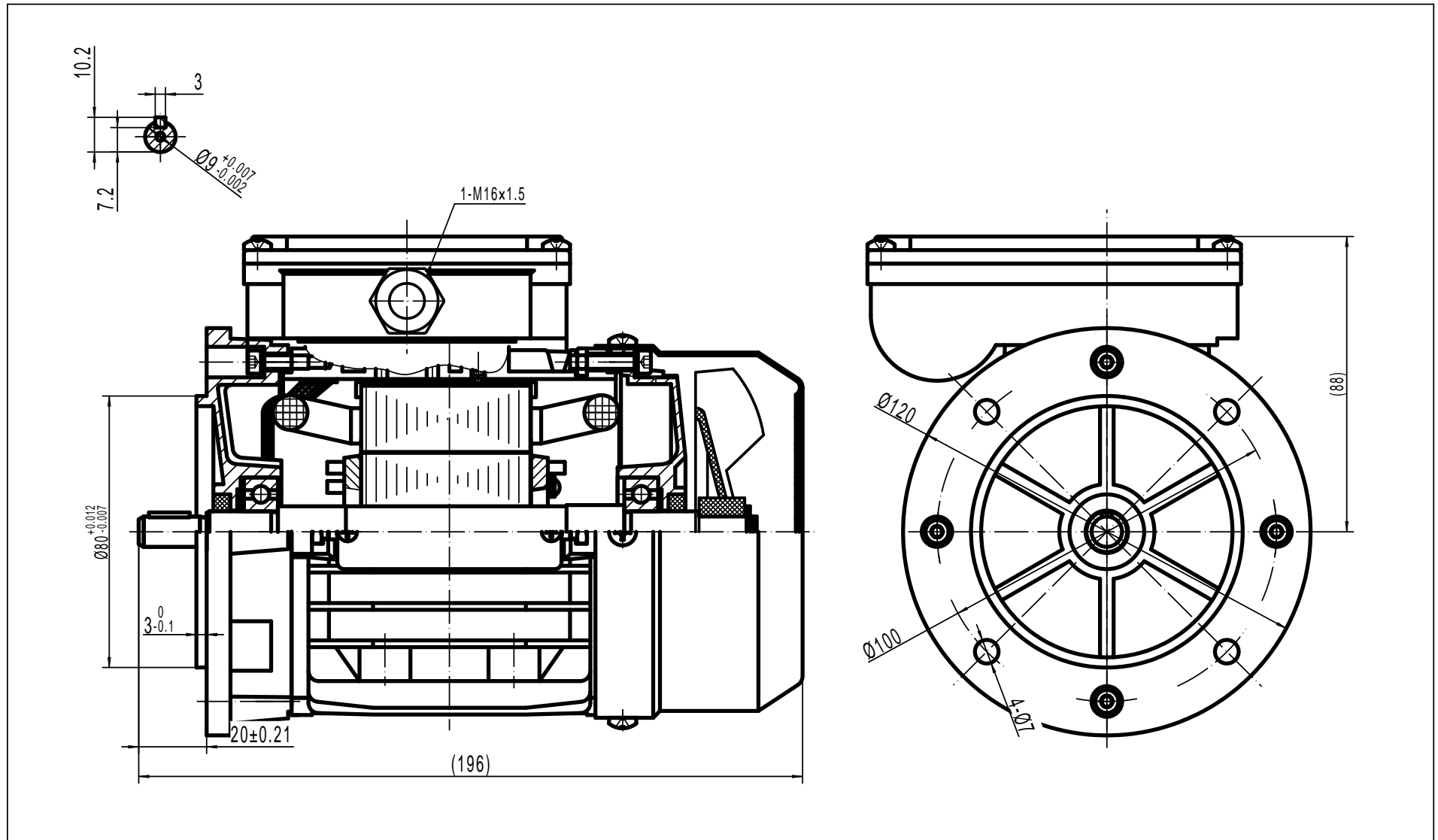

TECHTOP AUSTRALIA PTY LTD	
FRAME	TMY 56A B5
DATE	RAWING NO.
2008/05/20	1TB.390.002